

# INSTALLATION INSTRUCTIONS

## Apron Front Stainless Steel Sinks

# DUKO®

### KSS0006S-OL

35-7/8"x20-1/4"x10"



### Tools You Will Need

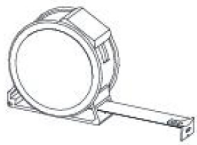

Measuring tape



Pencil

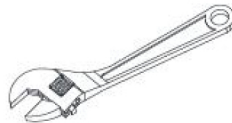

Wrenches



Safety goggles

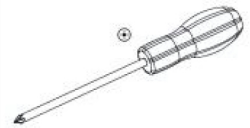

Phillips screwdriver



Silicone sealant

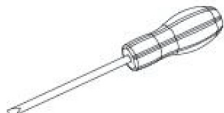

Flathead screwdriver

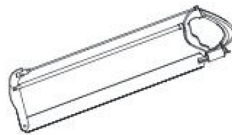

Hacksaw



Electric drill



Saber saw or jig saw

### INSTALLATION TIPS

- For optimum installation results homeowner, cabinet maker, countertop and sink installers should all be involved in the planning and installation process.
- The manufacturer suggests this sink be installed by a locally licensed professional and recommends using the actual sink to determine the final cabinet and countertop dimensions.
- Prior to installation be sure to inspect sink for damage. The manufacturer is not responsible for damage caused during installation or by improper installation.
- Be sure to use proper tools and always wear personal protective equipment for your safety.
- Caution: Metal edges may be sharp – handle with care.

## Step 1 – Preparing the base cabinet

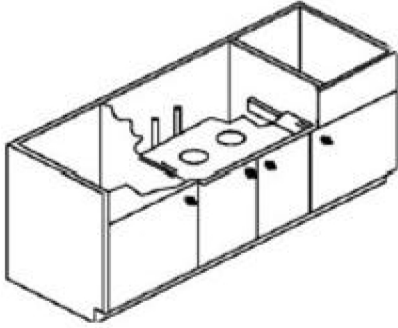

Apron sinks require a base cabinet with an opening in the front of the cabinet. In addition, unlike a standard undermount or top mount sink which may be supported by a countertop, this sink should be supported independently by the cabinet. The support should be sufficient for the weight of a completely filled sink plus any attachments such as garbage disposals and an additional safety factor. A licensed contractor should be able to design adequate support.

Depending on the width and structural integrity of your cabinet, this can generally be accomplished by mounting 2" x 4" wood supports on both inner cabinet side walls, or by building a platform (out of plywood and 2" x 4" vertical braces). We recommend gluing and screwing the bracing to the sink base cabinet, but take care that screws do not penetrate through to any finished, visible surfaces. The finished height of the support structure should be spaced to allow the sink (when placed on the support) to reach just touching the countertop material. Allow space in the platform for water line supplies and the sink drain hole or garbage disposal adapter.

## Step 2 – Fitting the base cabinet

Test fit the sink to the cabinet opening. Make any necessary adjustments to the width of the opening by either adding filler strips to the cabinet on the sides of the apron, or by cutting or sanding the cabinet opening to fit. These sinks are designed so that the apron sits forward approximately 1" outward from the face of the cabinet. Also, confirm the top of the sink is flush with the top of the cabinet so the countertop will make a tight seal.

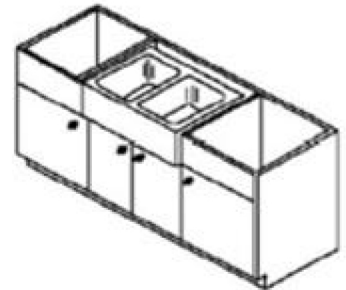

## Step 3 – Preparing the countertop

We recommends that apron sinks be installed either flush, where the countertop is cut to the exact size of the sink width, or with a "positive reveal", with the countertop edge sitting back from the bowl of the sink, exposing 1/16" to 1/4" of the sink rim, as seen in the cross section view here.



**\*\*Templates are supplied as a guide. We recommend using the actual sink for the most accurate cut.\*\***



## Step 4 – Installing the countertop

If using a solid surface counter such as quartz or granite, install the fabricated countertop by cleaning the bottom of the countertop and the top flange (or lip) of the sink with denatured alcohol. Then apply a narrow bead of silicone or adhesive sealant to the top edge of the bowl flange. Place the countertop on the sink. Remove excess sealant from the inside lip of the bowl using a cleaner recommended by the sealant supplier. For installation with other countertop materials and types, please consult your installer for professional installation advice.

## Care & Cleaning Guidelines

### Cleaning

- Daily, regular cleaning to remove dirt and prevent staining is recommended. Use liquid dish detergent, water and a soft household sponge.
- Mild, non-abrasive cleaners can be used with a nylon scrub pad. To ensure a uniform appearance in a stainless steel sink surface, rinse with water and wipe down the sink with a soft, dry cloth. Drying the sink will prevent water spots caused by time in the water.
- Remove stubborn stains from lime or calcium deposits by pouring a little warm vinegar or vinegar-based cleaner into the sink and allow it to sit for a few minutes. Rinse with clean water and dry.

Please note chlorides are found in most all soap, detergents, bleaches and cleansers. Chlorides can be harsh on stainless steel. Rinse your sink thoroughly after each use to remove any chloride residue.

### Scratches

Scratches are inevitable during your usage over time. To treat, use a nylon pad with an iron free abrasive polishing compound. Follow the original polish lines to blend out the scratch in a small area. Be cautious not to overdo the process, as cleaning too aggressively could result in a bright spot.

### Rust Spots

Stainless steel does not rust. Rust stains are the result of iron particles introduced by water, cookware, and steel wool pads that react with water to create rust. Metal cleaners will remove rust spots.

### Food Stains

Depending on the severity of the stain, use a bleach and water solution or pour the bleach onto a cloth and cover the stain. Allow the bleach to sit for at least 1/2 hour and then clean with dish detergent and water.

### Some Don'ts

- DO NOT use strong abrasive cleaners, metal scrub pads, or steel wool. These will scratch the surface.
- DO NOT leave rubber mats or sponges inside the sink. Water trapped below could lead to stains.
- DO NOT let food with a high salt content sit inside the sink for prolonged periods of time.
- DO NOT allow chlorine bleach to sit inside a stainless steel sink for more than 1 hour.
- DO NOT allow drain cleaners to come into contact with the sink surface.
- DO NOT pour paint in your sink. The chemicals in acrylic paint will react with sinks if allowed to sit over 24 hours and will produce permanent marks. For latex based paints, remove any residue immediately using a paint remover manufactured by the same brand. Consult the paint remover recommendations before using on the sink. For all sinks, we also recommend nail polish remover, rubbing alcohol or an acetone based paint remover to eliminate paint residue.